



' %"& inch E-paper Display Series



GDEP312TT2-D

Dalian Good Display Co., Ltd.

Revision History

Rev.	Issued Date	Revised Contents
0.1	2015-06-16	Preliminary
0.2	2015-11-19	Modify Page 4 3.Mechanical Specifications Module Weight : TBD → 474±20 g Page 5 Input/Output Terminals Modify FPC L2/L1/R1/R2 Pin description Pin 39 : No Connection→Common Voltage Pin 40 : Border→NC (No connection) Pin 41 : STV2→Start pulse gate driver 2 Add connector type : 196033-50041 Page 12 6-2) Panel DC characteristics Modify I _{VDD} : -/5/11→-/3/7 I _{GL} : -/6/8→-/4/9 I _{NEG} : -/18/410→-/7/415 I _{POS} : -/18/415→-/7/445 I _{COM} : -/TBD/-→-/1.2/- Panel Power : -/TBD/TBD→-/370/13300 P _{STBY} : -/-/TBD→-/-/1.32 I _{COM} inrush current : TBD→2A Delete Border supply Page 15 6-4)Panel AC characteristics Modify CLOCK & DATA TIMING drawing : D0~D7→D0~D15 Modify GATE OUTPUT TIMING : Mode→Mode1、2 Page 18 8. Optical characteristics R(%) : 30/35/- → 30/40/- Page 21 10. Reliability test Add Reliability item Page 24 Add Packing

TECHNICAL SPECIFICATION

CONTENTS

<i>NO.</i>	<i>ITEM</i>	<i>PAGE</i>
-	Cover	1
-	Revision History	2
-	Contents	3
1	General Description	4
2	Features	4
3	Mechanical Specifications	4
4	Mechanical Drawing of EPD module	5
5	Input/Output Terminals	7
6	Electrical Characteristics	12
7	Power Sequence	16
8	Optical Characteristics	18
9	Handling, Safety and Environment Requirements and Remark	19
10	Reliability test	21
11	Block Diagram	22
12	Packing	23

1. General Description

GDEP312TT2-D is a reflective electrophoretic E Ink technology display module based on active matrix TFT substrate. It has 31.2" active area with 2560 x 1440 pixels, the display is capable to display images at 2 to 16 gray levels (1 to 4 bits) depending on the display controller and the associated waveform file it used.

2. Features

- High contrast reflective/electrophoretic technology
- 2560 x 1440 display
- Ultra wide viewing angle
- Ultra low power consumption
- Pure reflective mode
- Bi-stable
- Commercial temperature range
- Landscape, portrait mode

3. Mechanical Specifications

Parameter	Specifications	Unit	Remark
Screen Size	31.2	Inch	
Display Resolution	2560 (H) × 1440 (V)	Pixel	
Active Area	691.2 (H) × 388.8 (V)	mm	
Outline Dimension	697.2(H) × 402.8(V) × 0.805(D)	mm	
Pixel Pitch	0.27 (H) × 0.27 (V)	mm	
Pixel Configuration	Square		
Module Weight	494	g	
Number of Gray	16 Gray Level (monochrome)		
Display operating mode	Reflective mode		
Glass Substrate	0.5	mm	
Surface Treatment	Hard Coating		
FPL	E Ink Pearl		

4. Mechanical Drawing of EPD Module

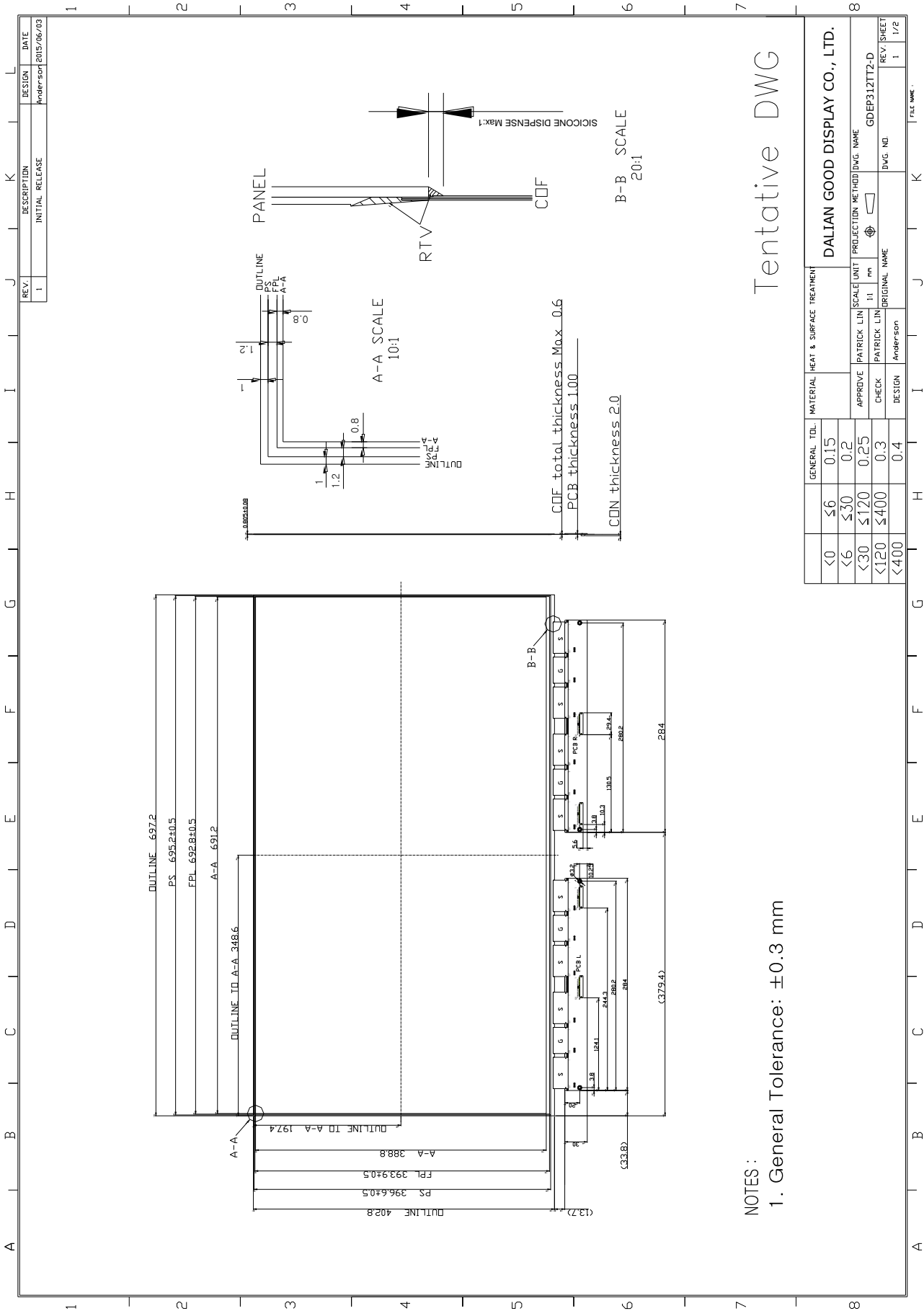

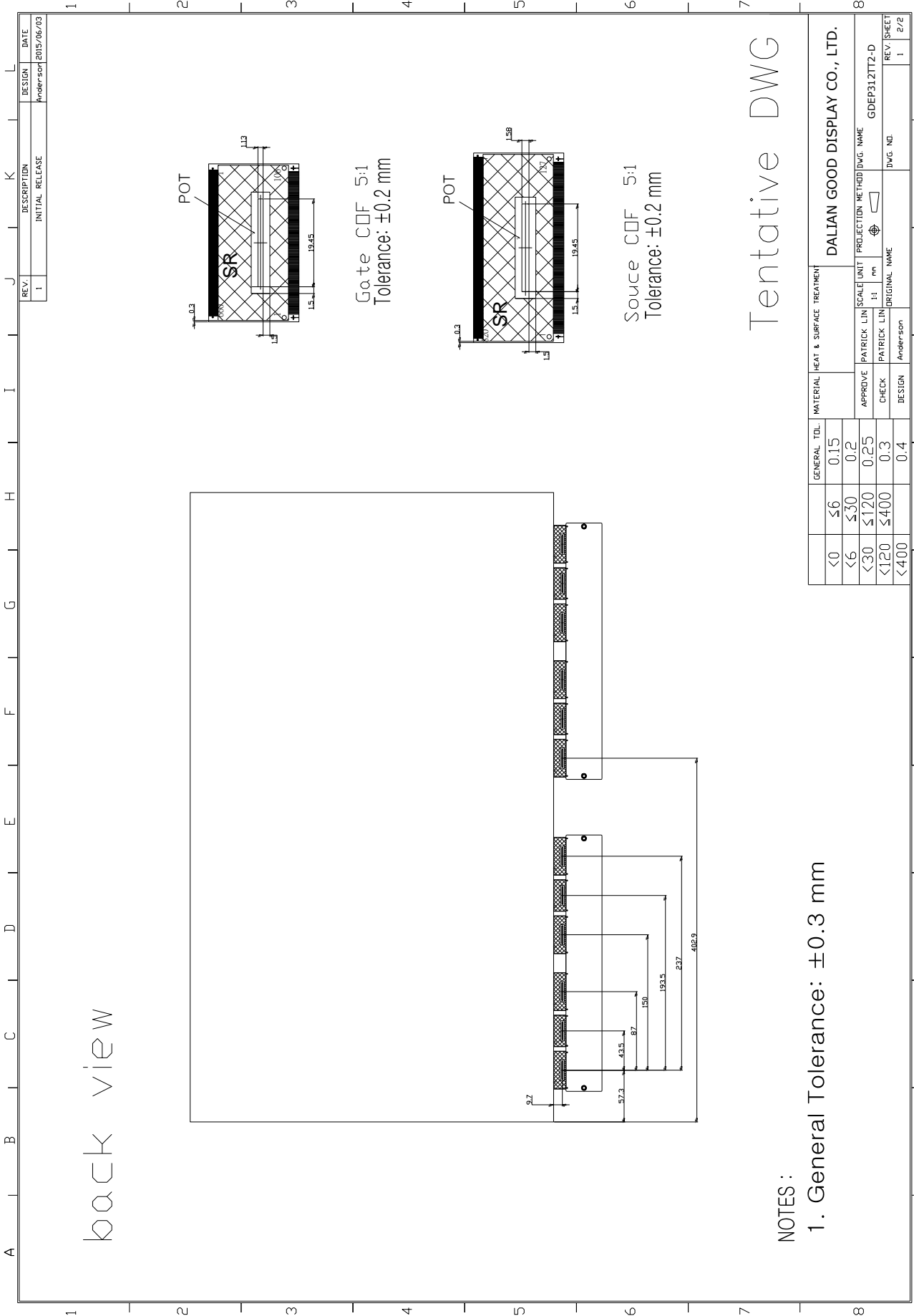

5. Input/Output Interface

5-1) Connector type : 196033-50041

5-2) Pin Assignment

Connector L2

Pin #	Signal	Description
1	VGL	Negative power supply gate driver
2	NC	NO Connection
3	VGH	Positive power supply gate driver
4	Mode2	Output mode selection gate driver
5	VDD	Digital power supply drivers
6	Mode1	Output mode selection gate driver
7	CKV	Clock gate driver
8	STV	Start pulse gate driver
9	VSS	Ground
10	VCOM TFT	Common voltage
11	VDD	Digital power supply drivers
12	VSS	Ground
13	XCL	Clock source driver
14	D0	Data signal source driver
15	D1	Data signal source driver
16	D2	Data signal source driver
17	D3	Data signal source driver
18	D4	Data signal source driver
19	D5	Data signal source driver
20	D6	Data signal source driver
21	D7	Data signal source driver
22	VSS	Ground
23	D8	Data signal source driver
24	D9	Data signal source driver
25	D10	Data signal source driver
26	D11	Data signal source driver
27	D12	Data signal source driver
28	D13	Data signal source driver
29	D14	Data signal source driver
30	D15	Data signal source driver
31	XSTL	Start pulse source driver
32	XLE	Latch enable source driver
33	XOE	Output enable source driver
34	ISEL	L: input data bus width is 8-bit, i.e., D7 ~ D0 are valid
35	NC	NO Connection
36	VPOS	Positive power supply source driver
37	NC	NO Connection
38	VNEG	Negative power supply source driver
39	VCOM FPL	Common Voltage
40	NC	NO Connection
41	STV2	Start pulse gate driver 2
42	G640	Detect IC function
43	S400	Detect IC function
44	S320	Detect IC function
45	NC	NO Connection
46	G640	Detect IC function
47	S400	Detect IC function
48	S320	Detect IC function
49	NC	NO Connection
50	STL2	Data shift start pulse 2

Connector L1

Pin #	Signal	Description
1	VGL	Negative power supply gate driver
2	NC	NO Connection
3	VGH	Positive power supply gate driver
4	Mode2	Output mode selection gate driver
5	VDD	Digital power supply drivers
6	Mode1	Output mode selection gate driver
7	CKV	Clock gate driver
8	STV	Start pulse gate driver
9	VSS	Ground
10	VCOM_TFT	Common voltage
11	VDD	Digital power supply drivers
12	VSS	Ground
13	XCL	Clock source driver
14	D0	Data signal source driver
15	D1	Data signal source driver
16	D2	Data signal source driver
17	D3	Data signal source driver
18	D4	Data signal source driver
19	D5	Data signal source driver
20	D6	Data signal source driver
21	D7	Data signal source driver
22	VSS	Ground
23	D8	Data signal source driver
24	D9	Data signal source driver
25	D10	Data signal source driver
26	D11	Data signal source driver
27	D12	Data signal source driver
28	D13	Data signal source driver
29	D14	Data signal source driver
30	D15	Data signal source driver
31	XSTL	Start pulse source driver
32	XLE	Latch enable source driver
33	XOE	Output enable source driver
34	ISEL	L: input data bus width is 8-bit, i.e., D7 ~ D0 are valid
35	NC	NO Connection
36	VPOS	Positive power supply source driver
37	NC	NO Connection
38	VNEG	Negative power supply source driver
39	VCOM_FPL	Common Voltage
40	NC	NO Connection
41	STV2	Start pulse gate driver 2
42	NC	NO Connection
43	NC	NO Connection
44	NC	NO Connection
45	NC	NO Connection
46	NC	NO Connection
47	NC	NO Connection
48	NC	NO Connection
49	NC	NO Connection
50	STL2	Data shift start pulse 2

Connector R1

Pin #	Signal	Description
1	VGL	Negative power supply gate driver
2	NC	NO Connection
3	VGH	Positive power supply gate driver
4	Mode2	Output mode selection gate driver
5	VDD	Digital power supply drivers
6	Mode1	Output mode selection gate driver
7	CKV	Clock gate driver
8	STV	Start pulse gate driver
9	VSS	Ground
10	VCOM_TFT	Common voltage
11	VDD	Digital power supply drivers
12	VSS	Ground
13	XCL	Clock source driver
14	D0	Data signal source driver
15	D1	Data signal source driver
16	D2	Data signal source driver
17	D3	Data signal source driver
18	D4	Data signal source driver
19	D5	Data signal source driver
20	D6	Data signal source driver
21	D7	Data signal source driver
22	VSS	Ground
23	D8	Data signal source driver
24	D9	Data signal source driver
25	D10	Data signal source driver
26	D11	Data signal source driver
27	D12	Data signal source driver
28	D13	Data signal source driver
29	D14	Data signal source driver
30	D15	Data signal source driver
31	XSTL	Start pulse source driver
32	XLE	Latch enable source driver
33	XOE	Output enable source driver
34	ISEL	L: input data bus width is 8-bit, i.e., D7 ~ D0 are valid
35	NC	NO Connection
36	VPOS	Positive power supply source driver
37	NC	NO Connection
38	VNEG	Negative power supply source driver
39	VCOM_FPL	Common Voltage
40	NC	NO Connection
41	STV2	Start pulse gate driver 2
42	NC	NO Connection
43	NC	NO Connection
44	NC	NO Connection
45	NC	NO Connection
46	NC	NO Connection
47	NC	NO Connection
48	NC	NO Connection
49	NC	NO Connection
50	STL2	Data shift start pulse 2

Connector R2

Pin #	Signal	Description
1	VGL	Negative power supply gate driver
2	NC	NO Connection
3	VGH	Positive power supply gate driver
4	Mode2	Output mode selection gate driver
5	VDD	Digital power supply drivers
6	Mode1	Output mode selection gate driver
7	CKV	Clock gate driver
8	STV	Start pulse gate driver
9	VSS	Ground
10	VCOM_TFT	Common voltage
11	VDD	Digital power supply drivers
12	VSS	Ground
13	XCL	Clock source driver
14	D0	Data signal source driver
15	D1	Data signal source driver
16	D2	Data signal source driver
17	D3	Data signal source driver
18	D4	Data signal source driver
19	D5	Data signal source driver
20	D6	Data signal source driver
21	D7	Data signal source driver
22	VSS	Ground
23	D8	Data signal source driver
24	D9	Data signal source driver
25	D10	Data signal source driver
26	D11	Data signal source driver
27	D12	Data signal source driver
28	D13	Data signal source driver
29	D14	Data signal source driver
30	D15	Data signal source driver
31	XSTL	Start pulse source driver
32	XLE	Latch enable source driver
33	XOE	Output enable source driver
34	ISEL	L: input data bus width is 8-bit, i.e., D7 ~ D0 are valid
35	NC	NO Connection
36	VPOS	Positive power supply source driver
37	NC	NO Connection
38	VNEG	Negative power supply source driver
39	VCOM_FPL	Common Voltage
40	NC	NO Connection
41	STV2	Start pulse gate driver 2
42	G640	Detect IC function
43	S400	Detect IC function
44	S320	Detect IC function
45	NC	NO Connection
46	NC	NO Connection
47	S320	Detect IC function
48	S400	Detect IC function
49	G640	Detect IC function
50	STL2	Data shift start pulse 2

5-3) Panel Scan direction

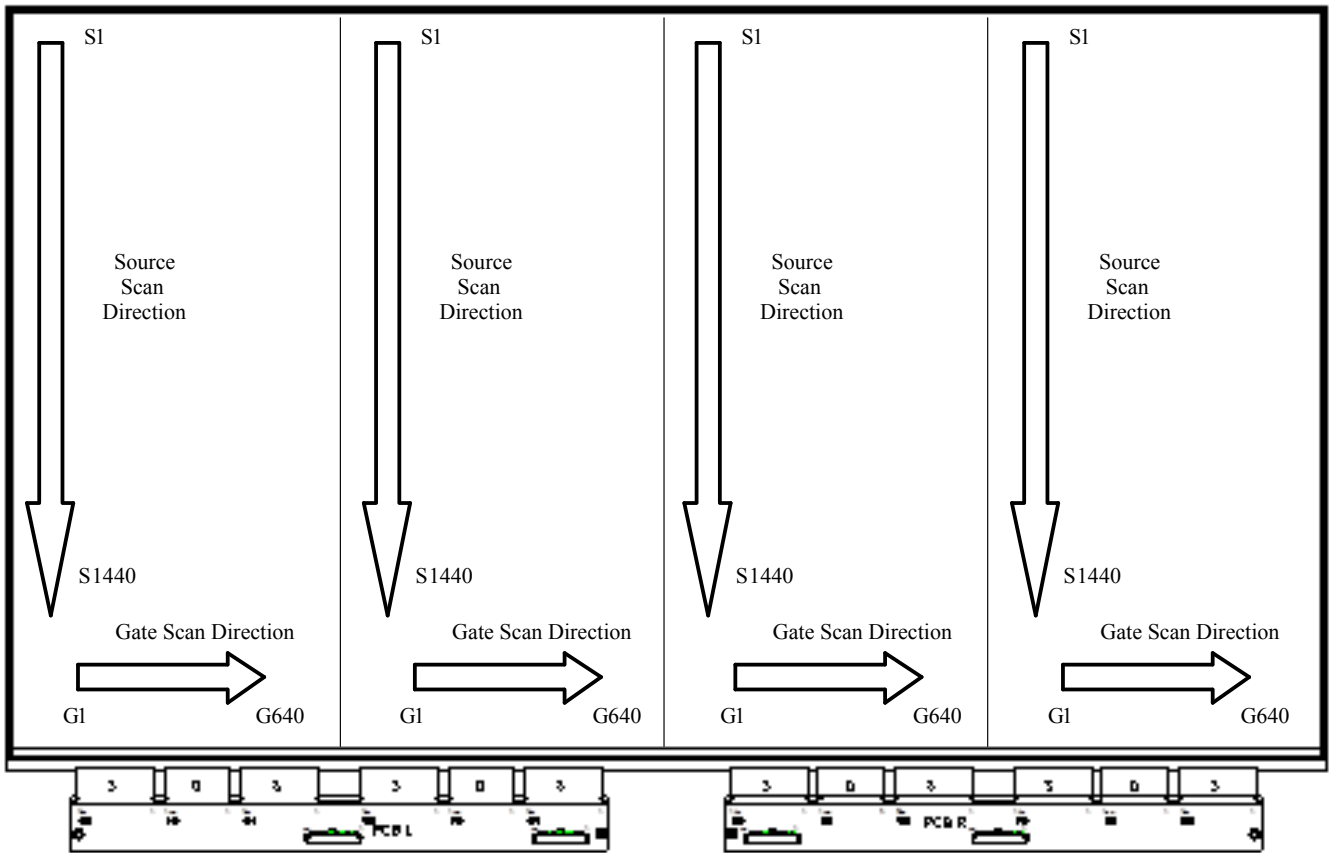

6. Electrical Characteristics

6-1) Absolute maximum rating

Parameter	Symbol	Rating	Unit	Remark
Logic Supply Voltage	VDD	-0.3 to +7	V	--
Positive Supply Voltage	V _{POS}	-0.3 to +18	V	--
Negative Supply Voltage	V _{NEG}	+0.3 to -18	V	--
Max .Drive Voltage Range	V _{POS} - V _{NEG}	36	V	--
Supply Voltage	VGH	-0.3 to +55	V	--
Supply Voltage	VGL	-32 to +0.3	V	--
Supply Range	VGH-VGL	-0.3 to +55	V	--
Operating Temp. Range	TOTR	0 to +50	°C	--
Storage Temperature	TSTG	-25 to +70	°C	--

6-2) Panel DC characteristics

Parameter	Symbol	Conditions	Min	Typ	Max	Unit
Signal ground	V _{SS}		-	0	-	V
Logic Voltage supply	V _{DD}		2.7	-	3.6	V
	I _{VDD}	V _{DD} = 3.3V	-	3	7	mA
Gate Negative supply	V _{GL}		-21	-	-19	V
	I _{GL}	V _{GL} = -20V	-	4	9	mA
Gate Positive supply	V _{GH}		21	-	23	V
	I _{GH}	V _{GH} = 22V	-	3	4	mA
Source Negative supply	V _{NEG}		-15.4	-	-14.6	V
	I _{NEG}	V _{NEG} = -15V	-	7	415	mA
Source Positive supply	V _{POS}		14.6	-	15.4	V
	I _{POS}	V _{POS} = 15V	-	7	445	mA
Asymmetry source	V _{Asym}	V _{POS} +V _{NEG}	TBD	-	TBD	mV
Common voltage	V _{COM}		TBD	Adjusted	TBD	V
	I _{COM}		-	1.2	-	mA
Panel power	P		-	370	13300	mW
Standby power panel	P _{STBY}		-	-	1.32	mW

- The maximum power consumption is measured using 50Hz waveform with following pattern transition: from pattern of repeated 1 consecutive black scan lines followed by 1 consecutive white scan line to that of repeated 1 consecutive white scan lines followed by 1 consecutive black scan lines. (Note 6-1)
- The Typical power consumption is measured using 50Hz waveform with following pattern transition: from horizontal 4 gray scale pattern to vertical 4 gray scale pattern. (Note 6-2)
- The standby power is the consumed power when the panel controller is in standby mode.
- The listed electrical/optical characteristics are only guaranteed under the controller & waveform provided by Good Display.
- Vcom is recommended to be set in the range of assigned value $\pm 0.1V$.
- The maximum I_{COM} inrush current is about 2 A

Note 6-1

The maximum power consumption

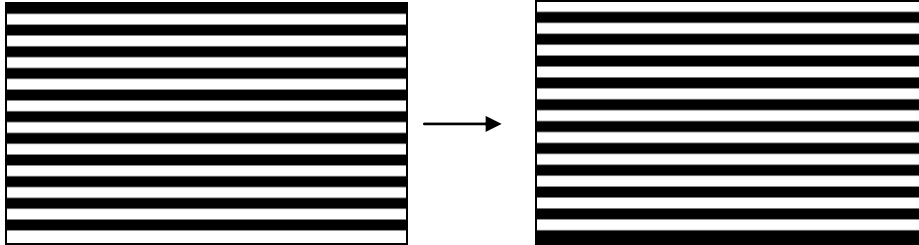

Note6-2

The Typical power consumption

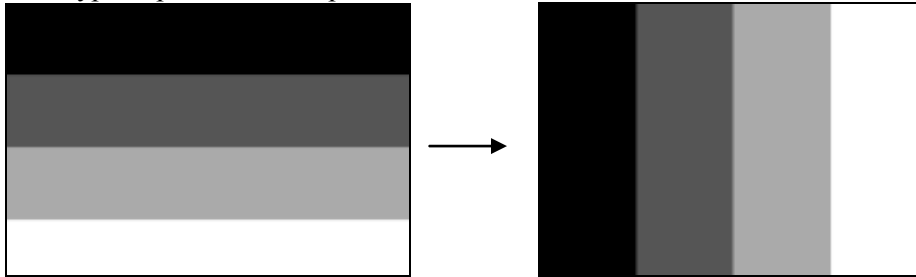

6-3)Refresh Rate

The module GDEP312TT2-D is applied at a maximum screen refresh rate of 50Hz.

	Min	Max
Refresh Rate	-	50Hz

6-4)Panel AC characteristics

VDD=2.7 V to 3.6V, unless otherwise specified.

Parameter	Symbol	Min.	Typ.	Max.	Unit
Clock frequency	fckv	-	-	200	kHz
Minimum “L” clock pulse width	twL	1	-	-	us
Clock rise time	trckv	-	-	100	ns
Clock fall time	tfckv	-	-	100	ns
SPV setup time	tSU	100	-	-	ns
SPV hold time	tH	100	-	-	ns
Pulse rise time	trspv	-	-	100	ns
Pulse fall time	tfspv	-	-	100	ns
Clock XCL cycle time	tey	16.7	20	-	ns
D0 .. D7 setup time	tsu	8	-	-	ns
D0 .. D7 hold time	th	8	-	-	ns
XSTL setup time	tstls	8	-	-	ns
XSTL hold time	tstlh	8	-	-	ns
XLE on delay time	tLEdly	40	-	-	ns
XLE high-level pulse width (When VDD=2.7V to 3.6V)	tLEw	40	-	-	ns
XLE off delay time	tLEoff	200	-	-	ns
Output setting time to +/- 30mV(C _{load} =200pF)	tout	-	-	12	us

OUTPUT LATCH CONTROL SIGNALS

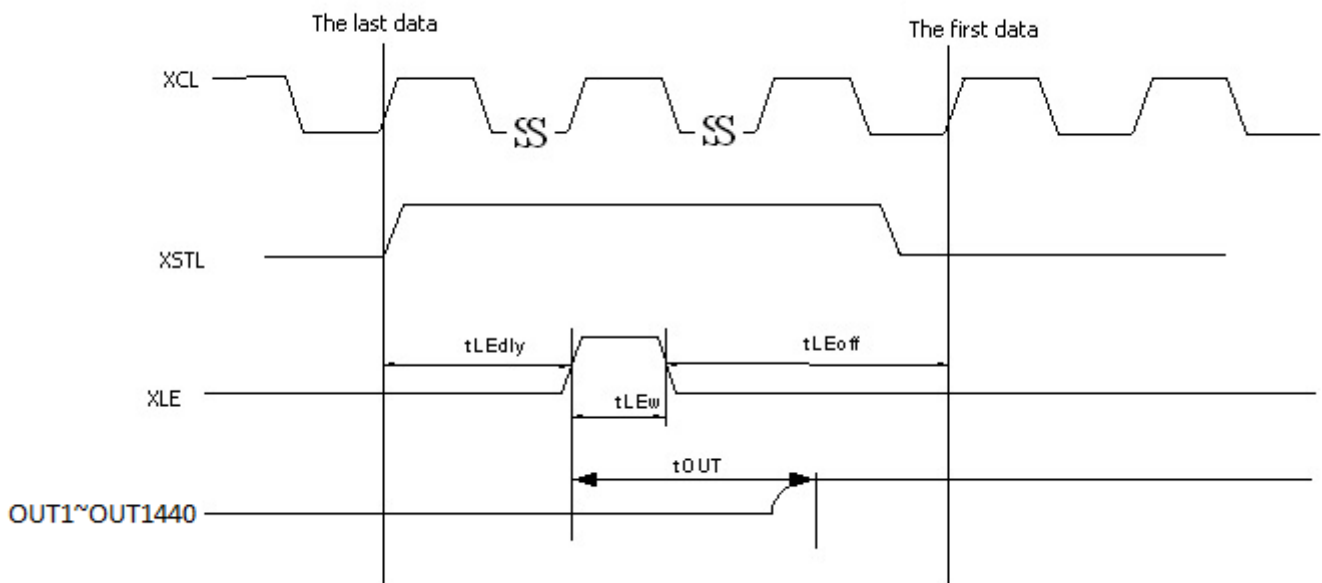

CLOCK & DATA TIMING

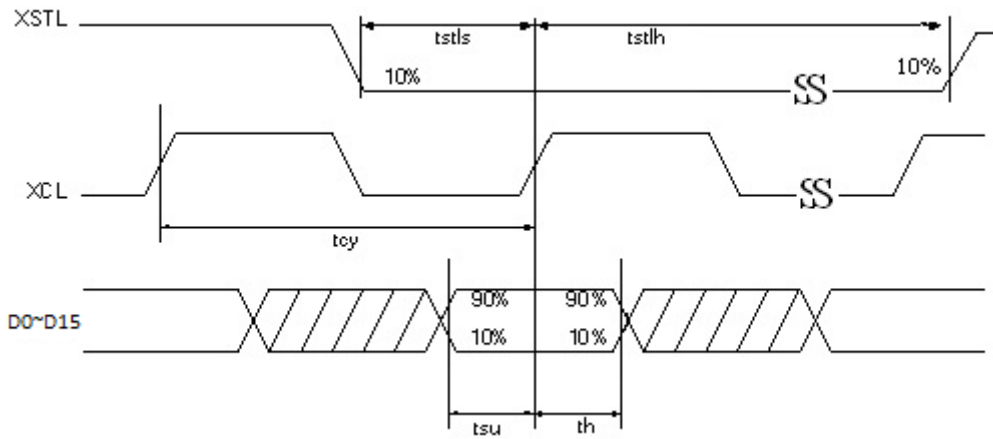

CKV & SPV TIMING

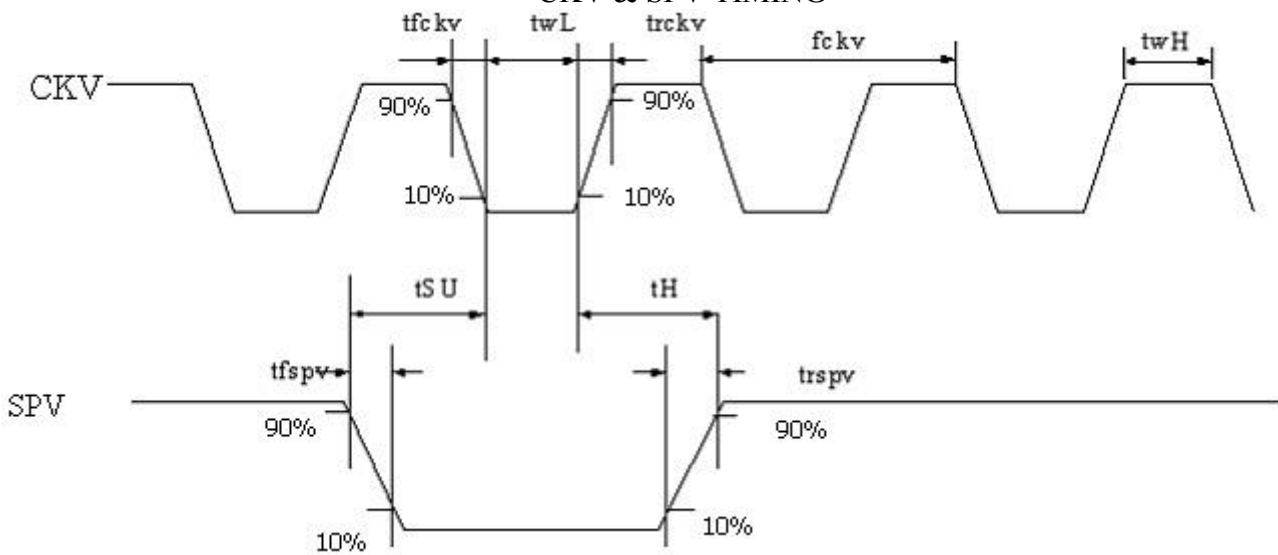

GATE OUTPUT TIMING

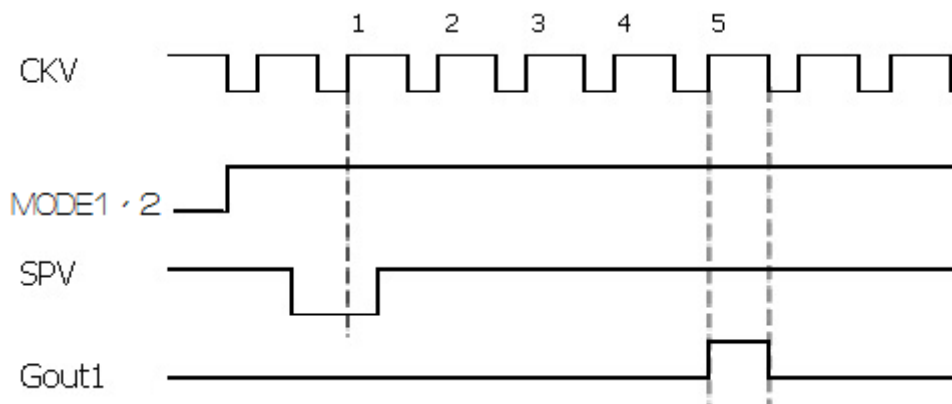

Note : First gate line on timing
After 5CKV , gate line is on .

7. Power Sequence

Power Rails must be sequenced in the following order :

1. VSS → VDD → VNEG → VPOS (Source driver) → VCOM
2. VSS → VDD → VGL → VGH (Gate driver)

Power on

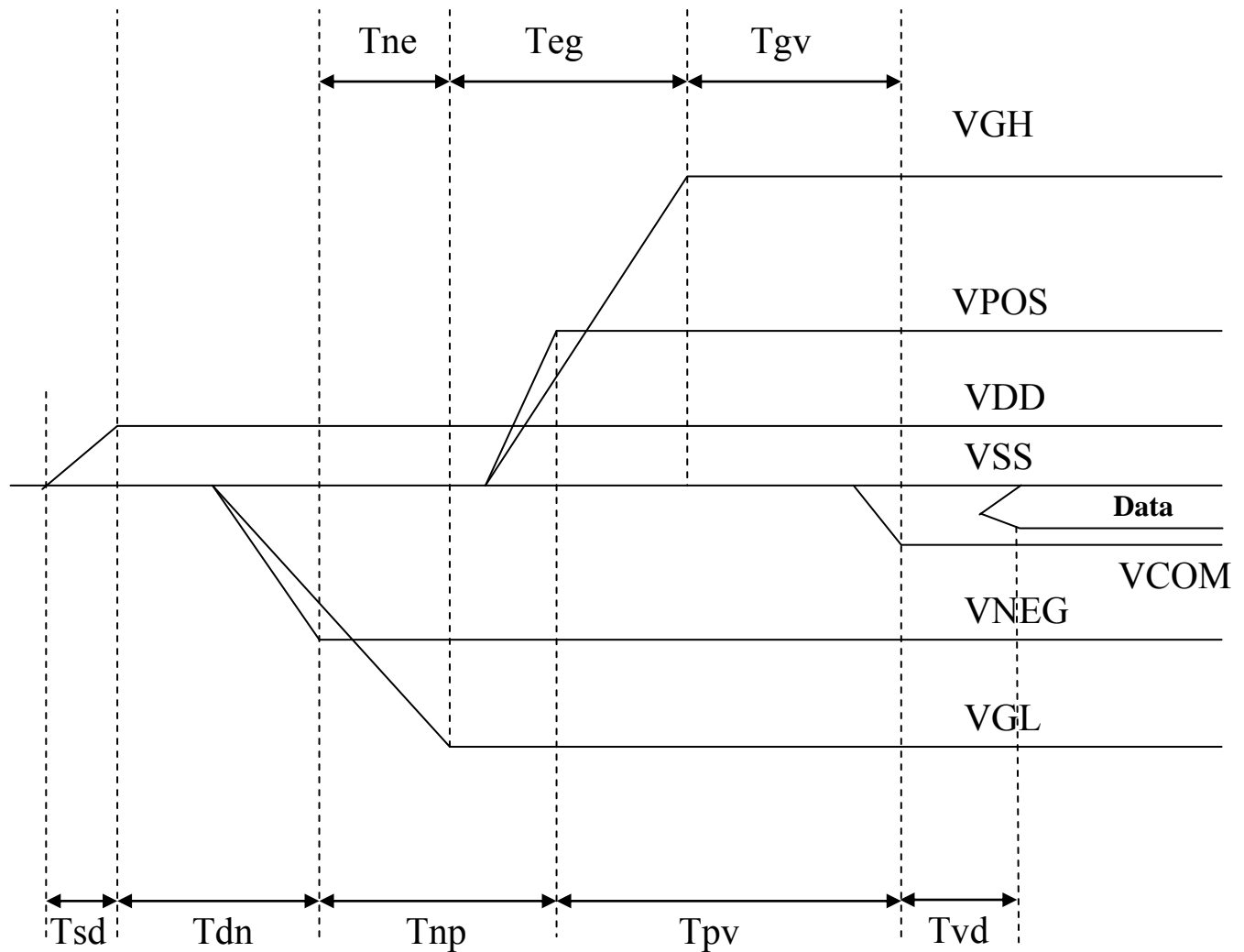

	Min	Max
Tsd	30us	-
Tdn	100us	-
Tnp	1000us	-
Tpv	100us	-
Tvd	100us	-
Tne	0us	-
Teg	1000us	-
Tgv	100us	-

Power off

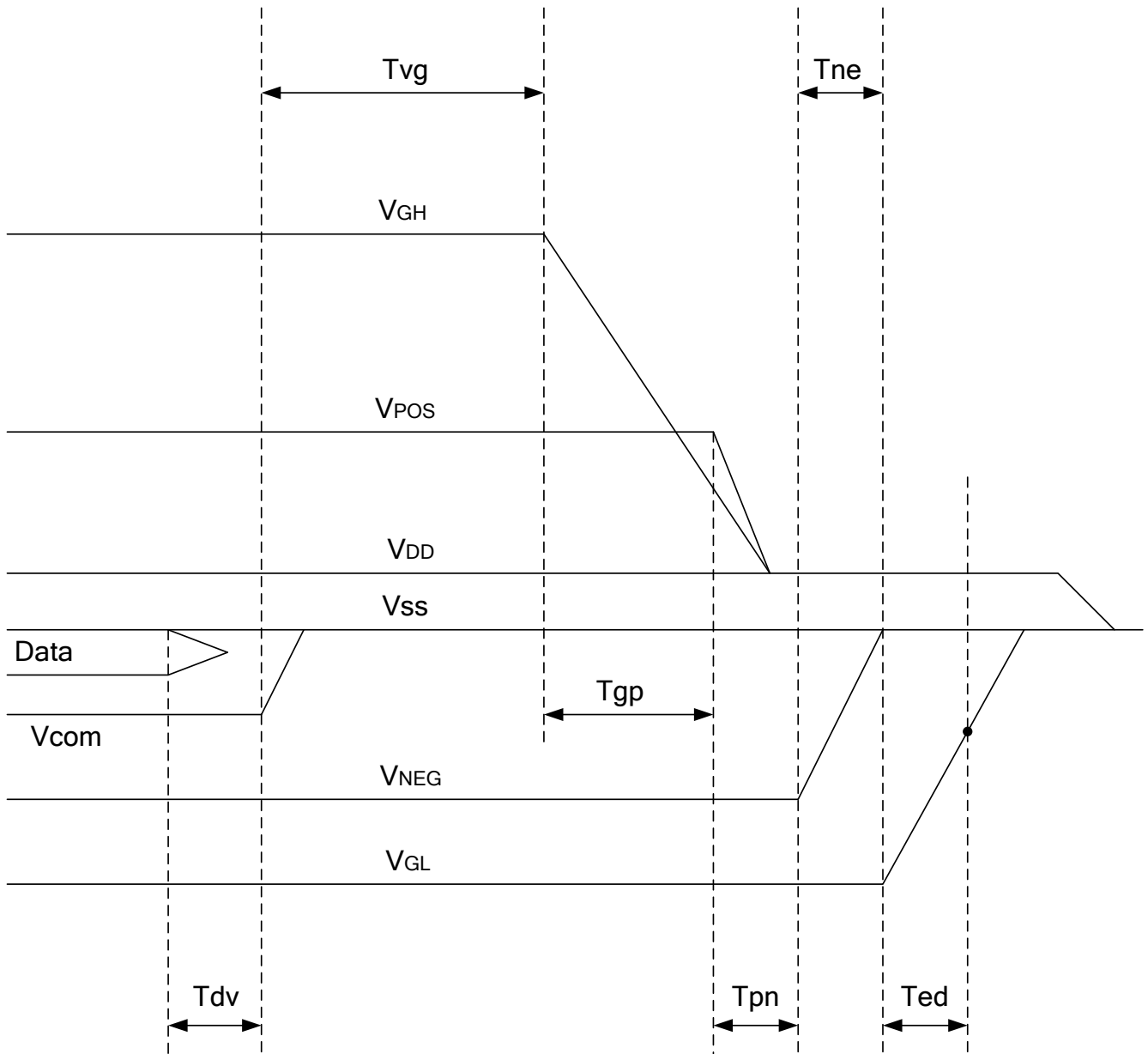

	Min	Max	
Tdv	100μs	-	
Tvg	0μs	-	
Tgp	0μs	-	
Tpn	0μs	-	
Tne	0μs	-	
Ted	0.5s	-	Discharged point @ -7.4 Volt

Note1 : Supply voltages decay through pull-down resistors.

Note2 : Begin to turn off VGL power after VNEG and VPOS are completely or almost discharged to GND state.

Note3 : VGL must remain negative of Vcom during decay period

8. Optical characteristics

8-1) Specifications

Measurements are made with that the illumination is under an angle of 45 degrees, the detector is perpendicular unless otherwise specified.

T = 25°C

Symbol	Parameter	Conditions	Min	Typ.	Max	Unit	Note
R	Reflectance	White	30	40	-	%	Note 8-1
Gn	N _{th} Grey Level	-	-	$DS+(WS-DS) \times n / (m-1)$	-	L*	-
CR	Contrast Ratio	-	10	12	-		

WS: White state , DS: Dark state, Gray state from Dark to White :DS 、 G1 、 G2... 、 Gn... 、 Gm-2 、 WS
 m:4 、 8 、 16 when 2 、 3 、 4 bits mode

Note 8-1: Luminance meter: Eye – One Pro Spectrophotometer

8-2) Definition of contrast ratio

The contrast ratio (CR) is the ratio between the reflectance in a full white area (Rl) and the reflectance in a dark area (Rd): $CR = Rl/Rd$

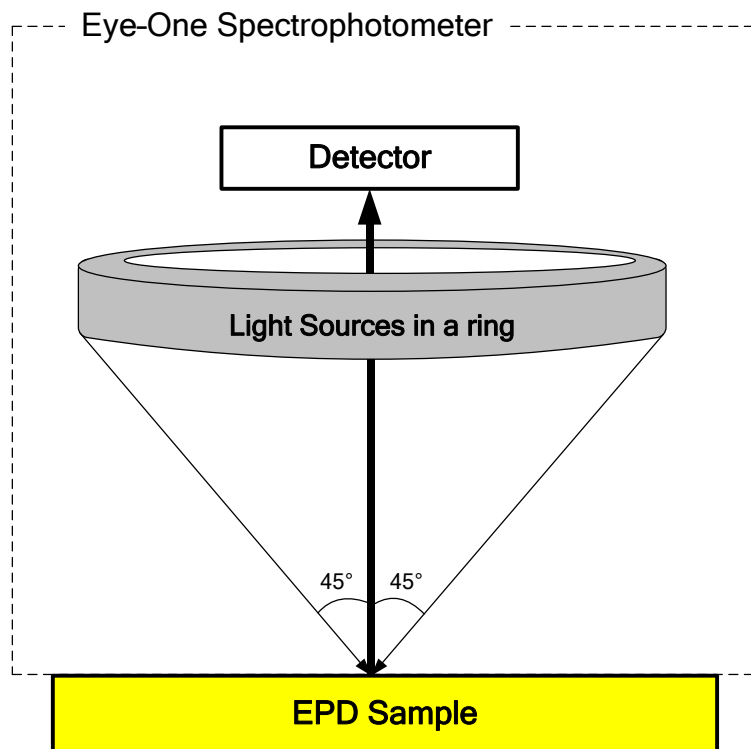

8-3) Reflection Ratio

The reflection ratio is expressed as:

$$R = \text{Reflectance Factor}_{\text{white board}} \times (L_{\text{center}} / L_{\text{white board}})$$

L_{center} is the luminance measured at center in a white area (R=G=B=1). $L_{\text{white board}}$ is the luminance of a standard white board. Both are measured with equivalent illumination source.

The viewing angle shall be no more than 2 degrees.

9. HANDLING, SAFETY AND ENVIROMENTAL REQUIREMENTS AND REMARK

WARNING
The display glass may break when it is dropped or bumped on a hard surface. Handle with care. Should the display break, do not touch the electrophoretic material. In case of contact with electrophoretic material, wash with water and soap.

CAUTION
The display module should not be exposed to harmful gases, such as acid and alkali gases, which corrode electronic components.
Disassembling the display module can cause permanent damage and invalidate the warranty agreements.
IPA solvent can only be applied on active area and the back of a glass. For the rest part, it is not allowed.

Mounting Precautions
(1) It's recommended that you consider the mounting structure so that uneven force (ex. Twisted stress) is not applied to the module.
(2) It's recommended that you attach a transparent protective plate to the surface in order to protect the EPD. Transparent protective plate should have sufficient strength in order to resist external force.
(3) You should adopt radiation structure to satisfy the temperature specification.
(4) Acetic acid type and chlorine type materials for the cover case are not desirable because the former generates corrosive gas of attacking the PS at high temperature and the latter causes circuit break by electro-chemical reaction.
(5) Do not touch, push or rub the exposed PS with glass, tweezers or anything harder than HB pencil lead. And please do not rub with dust clothes with chemical treatment. Do not touch the surface of PS for bare hand or greasy cloth. (Some cosmetics deteriorate the PS)
(6) When the surface becomes dusty, please wipe gently with absorbent cotton or other soft materials like chamois soaks with petroleum benzene. Normal-hexane is recommended for cleaning the adhesives used to attach the PS. Do not use acetone, toluene and alcohol because they cause chemical damage to the PS.
(7) Wipe off saliva or water drops as soon as possible. Their long time contact with PS causes deformations and color fading.
Data sheet status
Product specification
This data sheet contains Preliminary product specifications.

Limiting values

Limiting values given are in accordance with the Absolute Maximum Rating System (IEC 134). Stress above one or more of the limiting values may cause permanent damage to the device. These are stress ratings only and operation of the device at these or at any other conditions above those given in the Characteristics sections of the specification is not implied. Exposure to limiting values for extended periods may affect device reliability.

Application information

Where application information is given, it is advisory and does not form part of the specification.

Remark

All the specifications listed in this document are guaranteed for module only. Post-assembled operation or component(s) may impact module performance or cause unexpected effect or damage and therefore listed specifications is not warranted after any post-assembly operation.

10. Reliability test

	TEST	CONDITION	METHOD	REMARK
1	High-Temperature Operation	T = +50°C, RH = 30% for 240 hrs	IEC 60 068-2-2Bp	
2	Low-Temperature Operation	T = 0°C for 240 hrs	IEC 60 068-2-2Ab	
3	High-Temperature Storage	T = +70°C, RH=23% for 240 hrs Test in white pattern	IEC 60 068-2-2Bp	
4	Low-Temperature Storage	T = -25°C for 240 hrs Test in white pattern	IEC 60 068-2-1Ab	
5	High-Temperature, High-Humidity Operation	T = +40°C, RH = 90% for 168 hrs	IEC 60 068-2-3CA	
6	High Temperature, High- Humidity Storage	T = +60°C, RH=80% for 168 hrs Test in white pattern	IEC 60 068-2-3CA	
7	Temperature Cycle	-25°C → +70°C, 100 Cycles 30min 30min Test in white pattern	IEC 60 068-2-14	
8	Solar radiation test	765 W/m ² for 168hrs,40°C Test in white pattern	IEC60 068-2-5Sa	
9	Package Vibration	1.04G, Frequency: 10~500Hz Direction: X,Y,Z Duration: 1 hours in each direction	Full packed for shipment	
10	Package Drop Impact	Drop from height of 122 cm on concrete surface. Drop sequence: 1 corner, 3 edges, 6 faces One drop for each.	Full packed for shipment	
11	Electrostatic Effect (non-operating)	(Machine model)+/- 250V 0Ω, 200pF	IEC 62179, IEC 62180	

Actual EMC level to be measured on customer application

Note: The protective film must be removed before temperature test.

< Criteria >

In the standard conditions, there is not display function NG issue occurred. (including : line defect ,no image). All the cosmetic specification is judged before the reliability stress.

11. Block Diagram

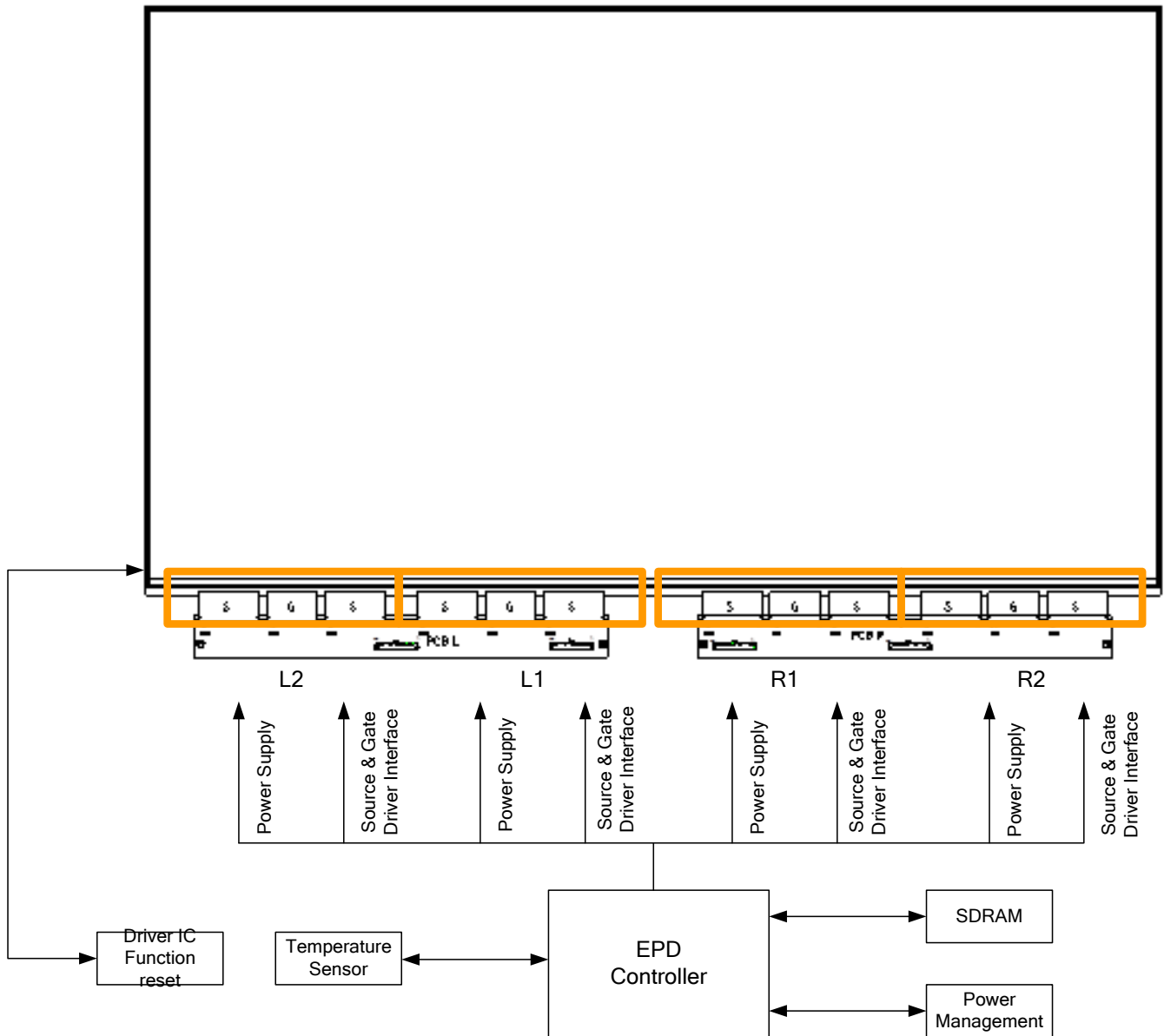

12.Packing

12-1)Packing drawing

REV.	DESCRIPTION	DESIGN	DATE
01	INITIAL RELEASE		

1

3(*10pcs)

2(*11pcs)

乾燥劑*2pcs

RUST INHIBITOR*4pcs

LABEL

束帶*4pcs

LABEL

NOTE:
 1.Q'TY:10 pcs panel/carton.
 2.Dimension: 890*760*138mm
 3.Weight: KG

ITEM	PART NO	PART NAME	Q'ty
1		PP BOX	1
2		Cushion Sheet(2mm)	11
3		EPD Signage B/W	10
4		乾燥劑	2
5		RUST INHIBITOR,25L	4
6		LABEL	2
7		束帶	4
8			

MTL.SPEC.	UNSPECIFIED TOL'S ANGLE ROUGHNESS	REMARK	DALIAN GOOD DISPLAY CO., LTD.			
APPROVE		SCALE 1:1	UNIT mm	SHEET 1 OF 1	DWG.TITLE 31.2" Packing Draw	
CHECK		MTL.NO.		DWG.NO.		REV. 01
DESIGN						A4 SIZE

12-2) Label position

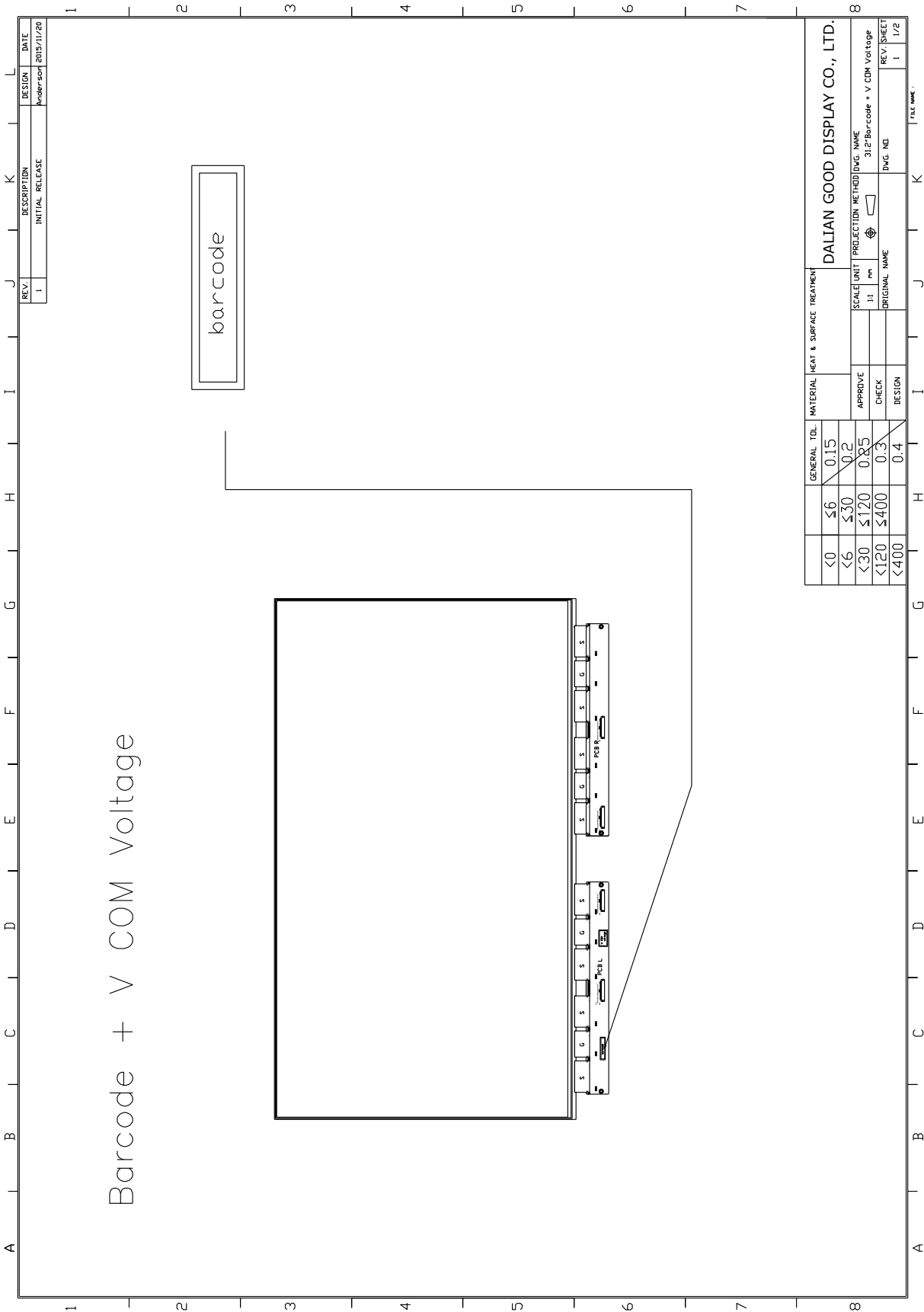

12-3) Pallet Stacking

Note: Stacking layer limitation: 18 layers.

